

DRAINGOTEN

MAXI 100 klasse A/F (C35/45) OPTIES

Roosters

Gietijzeren rooster KLASSE C250

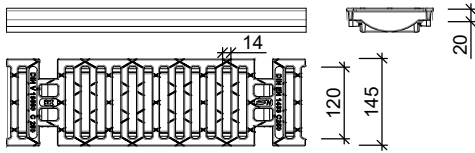

Gietijzeren rooster KLASSE C250

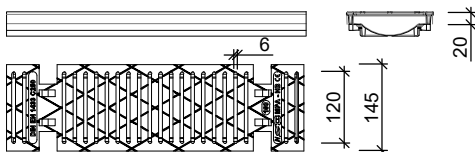

Gietijzeren rooster KLASSE D400

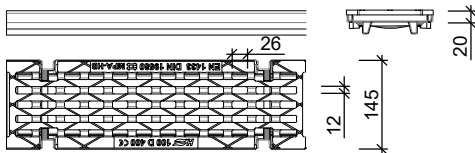

Gietijzeren rooster KLASSE E600

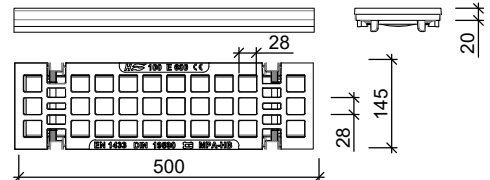

Gietijzeren rooster KLASSE F900

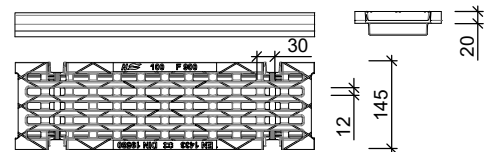

Afvoerelement

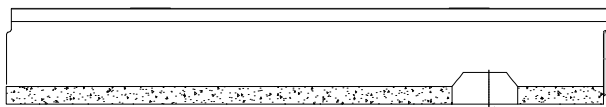

Verlaagde goot

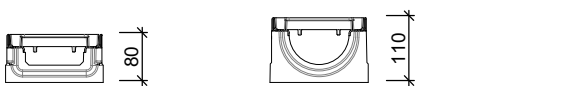

Zandvangput

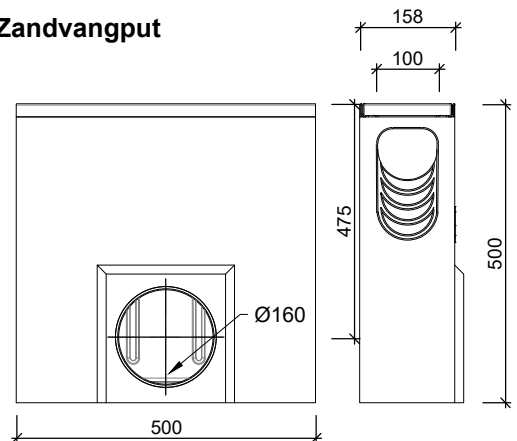

Begin-/Eindplaat



Kenmerken					MAXI 100	Principe
lengte (mm)	type afdekking	Oppervlakte inlaat (cm ²)	gewicht (kg)	belastingsklasse		
500	Gietijzeren rooster (14x120)	175	4,2	C250	<p>Plaatsingsvoorschriften op aanvraag</p>	
500	Gietijzeren rooster (6x20)	175	5,1	C250		
500	Gietijzeren rooster (26x12)	256	5,5	D400		
500	Gietijzeren rooster (28x28)	360	5,2	E600		
500	Gietijzeren rooster (30x12)	256	7,1	F900		
500	Zandvangput		43,0			

afmetingen in mm - wijzigingen voorbehouden

o product op verzoek (afname verplicht) / + standaard product / - niet leverbaar