

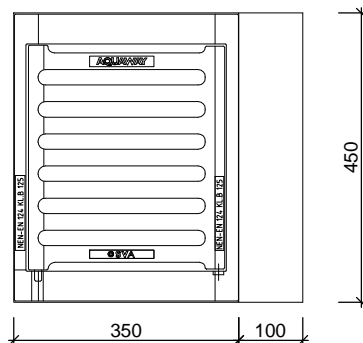

STRAATKOLKEN TWEEDELIG AQUAWAY® S 1366-1320 M-LINE

Toepassing:
Afvoeren van hemelwater,
in molgoten, prefab of gestort.

Bovenaanzicht



Zijaanzichten

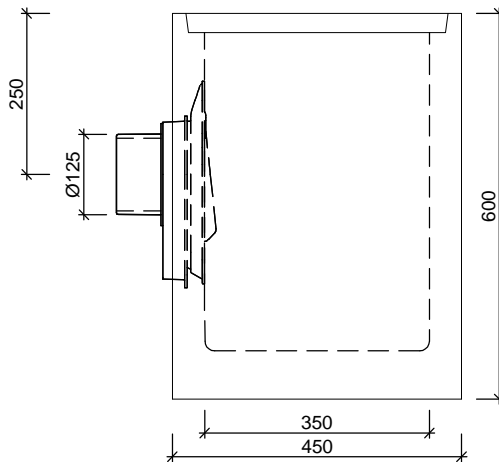
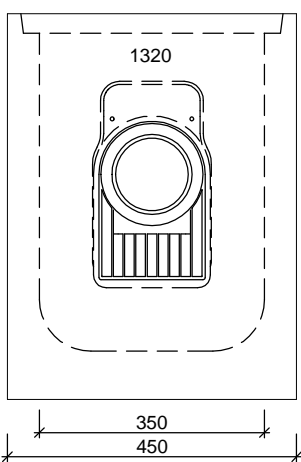
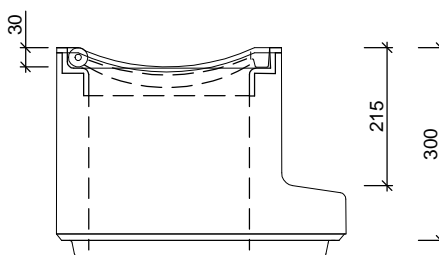
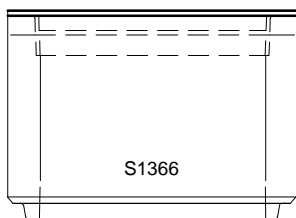

Standaard:

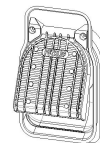

Scharnierende
Putklep

Toebehoren in optie:

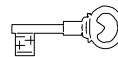

vergrendeling

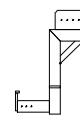

stelhulp kolken

Kenmerken	S 1366-1320 M-LINE GB2	Principe								
afmetingen	450/350/900mm	<table border="1"> <thead> <tr> <th>voor</th> <th>achter</th> <th>links</th> <th>rechts</th> </tr> <tr> <td>+</td> <td>+</td> <td>+</td> <td>+</td> </tr> </thead> </table>	voor	achter	links	rechts	+	+	+	+
voor	achter		links	rechts						
+	+	+	+							
gewicht	BS 77kg / OB 146kg									
Ø aansluiting	DN125	<p>Plaatsingsvoorschriften op aanvraag</p>								
holling rooster	30mm									
rooster inlaatopeningen	520cm ²									
stankslot	≥ 40mm									
zandvang	> 30dm ³									
gietijzer kwaliteit rand	GJL									
gietijzer kwaliteit rooster	GJS									
keur	NL BSB									
verkeersbelastingsklasse	B125									
materiaal	beton / GY									

Afmetingen in mm - Wijzigingen voorbehouden

o product op verzoek (afname verplicht) / + standaard product / - niet leverbaar