

STRAATKOLKEN TWEEDELIG

AQUAWAY® S 1332-1325 P-LINE GB2

Toepassing:
Afvoeren van hemelwater,



Bovenaanzicht

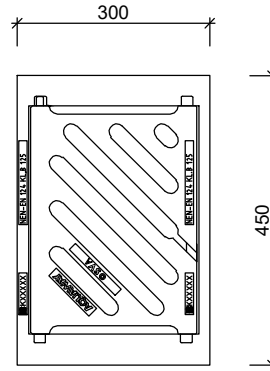

Standaard:

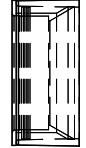

Flex ring

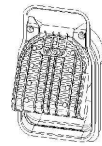

Scharnierende Putklep

zijaanzichten

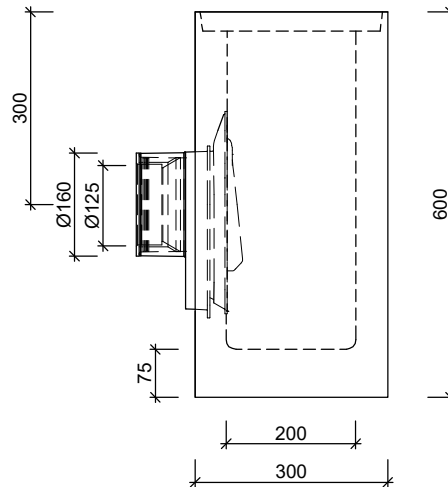
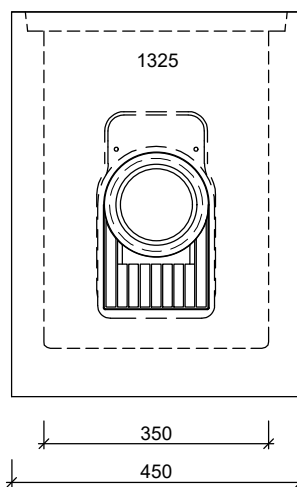
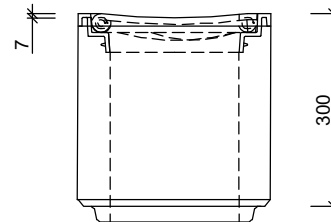
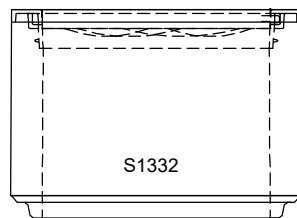

Toebehoren in optie:

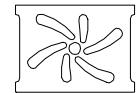

waaierrooster C250

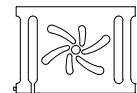

waaierrooster B125 met vergrendeling

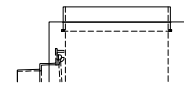

stalen geleiderand 1337-1315 Hoogte 50mm

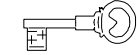

vergrendeling

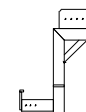

stelhulp kolken

Kenmerken	S 1332-1325 P-LINE GB2	Principe
afmetingen	450/300/900mm	aansluiting
gewicht	BS 56kg / OB 108kg	voor +
Ø aansluiting	FLEX DN125/DN160	achter +
holling rooster	7mm	links +
rooster inlaatopeningen	317cm ²	rechts +
stankslot	≥ 40mm	<p>Plaatsingsvoorschriften op aanvraag</p>
zandvang	> 20dm ³	
gietijzer kwaliteit rand	GJL	
gietijzer kwaliteit rooster	GJS	
keur	KOMO	
verkeersbelastingsklasse	B125	
materiaal	beton / GY	

afmetingen in mm - wijzigingen voorbehouden

o product op verzoek (afname verplicht) / + standaard product / - niet leverbaar