

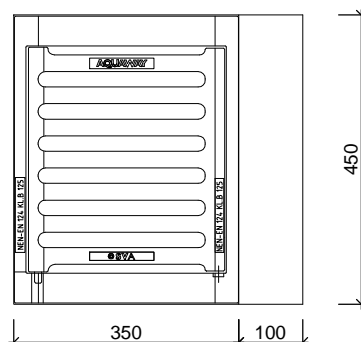

# STRAATKOLKEN TWEEDELIG AQUAWAY® S 1366-1320 P-LINE

Toepassing:  
Afvoeren van hemelwater,

## Bovenaanzicht



## Zijaanzichten

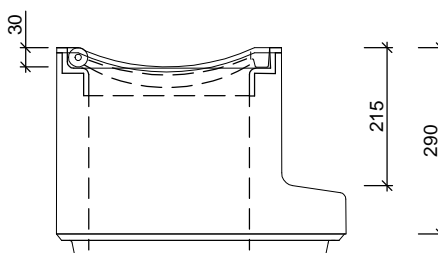
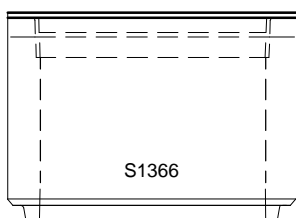

Standaard:

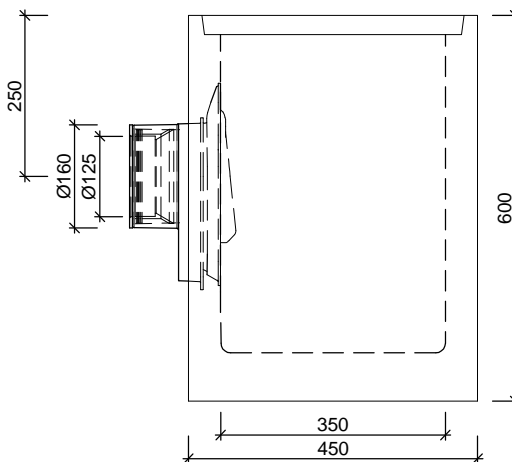
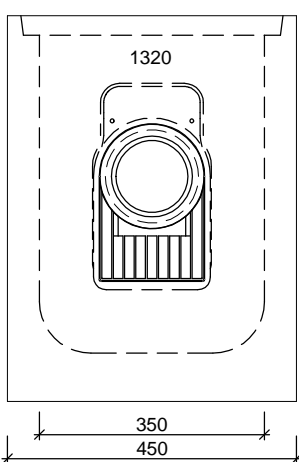

Scharnierende  
Putklep

Toebehoren in optie:

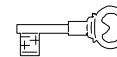

vergrendeling

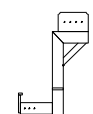

stelhulp kolken

Kenmerken		S 1366-1320 P-LINE GB2	Principe			
afmetingen		450x350 / 450x450 / 900mm	aansluiting			
gewicht		BS 77kg / OB 146kg	voor	achter	links	rechts
Ø aansluiting		FLEX DN125/DN160	+	+	+	+
holling rooster		30mm				
rooster inlaatopeningen		520cm <sup>2</sup>				
stankslot		≥ 40mm	Plaatsingsvoorschriften op aanvraag			
zandvang		> 30dm <sup>3</sup>				
gietijzer kwaliteit rand		GJL				
gietijzer kwaliteit rooster		GJS				
keur		NL BSB				
verkeersbelastingsklasse		B125				
materiaal		beton / GY				

Afmetingen in mm - Wijzigingen voorbehouden

o product op verzoek (afname verplicht) / + standaard product / - niet leverbaar