

# TROTTOIRKOLKEN EENDELIG

## AQUAWAY® T 1271/60 P-LINE GB1

Toepassing:  
Afvoeren van hemelwater, passende in de trottoirband.



### Bovenaanzicht

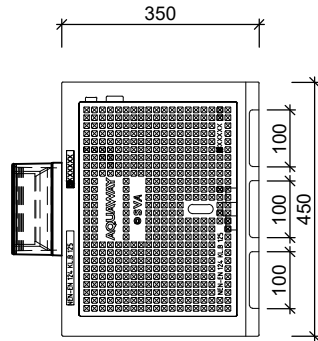

### Zijaanzichten

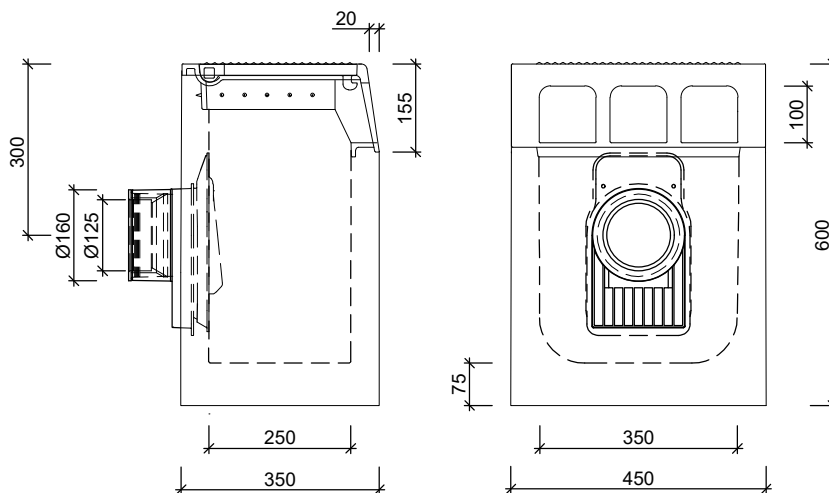

Standaard:

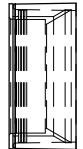

Flex ring

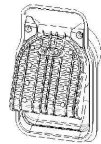

Scharnierende  
Putklep

Toebehoren in optie:

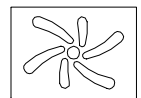

waaierdeksel  
B125

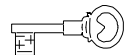

vergrendeling

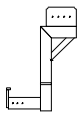

stelhulp kolken

Kenmerken		T 1271/60 P-LINE GB1	Principe															
afmetingen		450/350/600mm	<table border="1"> <tr> <th colspan="4">aansluiting</th> </tr> <tr> <th>voor</th> <th>achter</th> <th>links</th> <th>rechts</th> </tr> <tr> <td>o</td> <td>+</td> <td>+</td> <td>+</td> </tr> </table>				aansluiting				voor	achter	links	rechts	o	+	+	+
aansluiting																		
voor	achter	links	rechts															
o	+	+	+															
gewicht		135 kg	<p>trotsloot</p> <p>afvoer</p> <p>Plaatsingsvoorschriften op aanvraag</p>															
Ø aansluiting		FLEX DN125/DN160																
rooster inlaatopeningen		300cm <sup>2</sup>																
stankslot		≥ 40mm																
zandvang		> 5dm <sup>3</sup>																
gietijzer kwaliteit rand		GJL																
gietijzer kwaliteit rooster		GJS																
keur		KOMO																
verkeersbelastingsklasse		B125																
materiaal		beton / GY																
voor bandprofiel		13/15; 18/20; 28/30																

afmetingen in mm - wijzigingen voorbehouden

o product op verzoek (afname verplicht) / + standaard product / - niet leverbaar