

TROTTOIRKOLKEN EENDELIG AQUAWAY® T 1370.3/90 P-LINE GB1

Toepassing:
Afvoeren van hemelwater, passende in trottoirband.

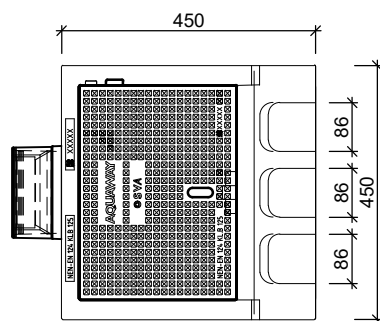

Bovenaanzicht



Standaard:



Flex ring

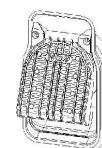

Scharnierende
Putklep

Zijaanzichten

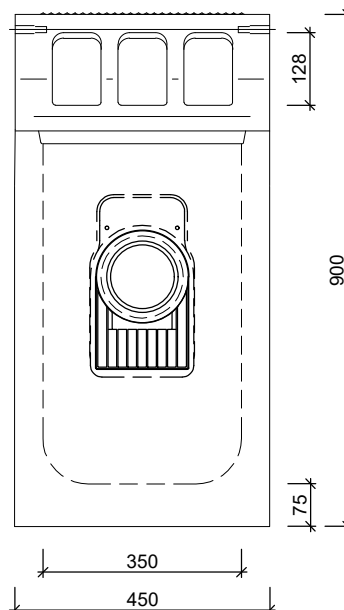
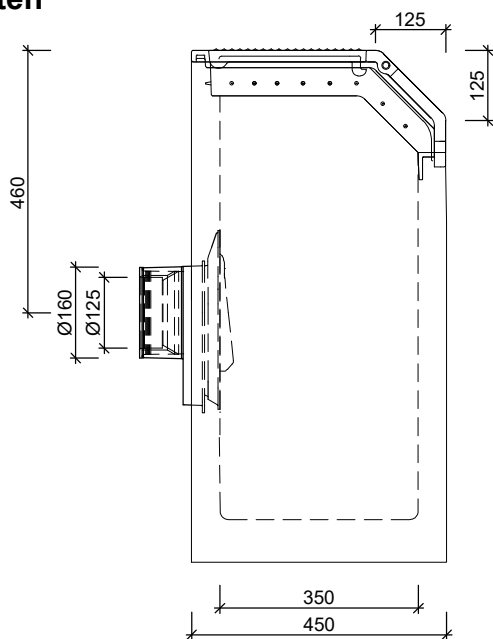

Toebehoren in optie:

uitlaat DN160

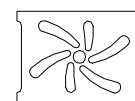

waaierdeksel
B125

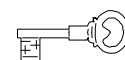

vergrendeling

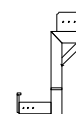

stelhulp kolken

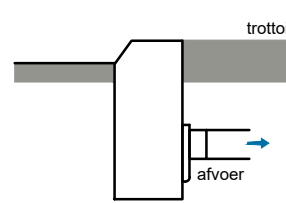
Kenmerken	T 1370.3/90 P-LINE GB1	Principe												
afmetingen	450/450/900mm	<table border="1"> <tr> <td colspan="4">aansluiting</td> </tr> <tr> <td>voor</td> <td>achter</td> <td>links</td> <td>rechts</td> </tr> <tr> <td>o</td> <td>+</td> <td>+</td> <td>+</td> </tr> </table>	aansluiting				voor	achter	links	rechts	o	+	+	+
aansluiting														
voor	achter	links	rechts											
o	+	+	+											
gewicht	220kg	 <p>Plaatsingsvoorschriften op aanvraag</p>												
Ø aansluiting	FLEX DN125/DN160													
rooster inlaatopeningen	380cm ²													
stankslot	≥ 40mm													
zandvang	> 20dm ³													
gietijzer kwaliteit rand	GJL													
gietijzer kwaliteit rooster	GJS													
keur	KOMO													
verkeersbelastingsklasse	B125													
materiaal	beton / GY													
voor bandprofiel	RWS 11/22													

afmetingen in mm - wijzigingen voorbehouden

o product op verzoek (afname verplicht) / + standaard product / - niet leverbaar