

TROTTOIRKOLKEN EENDELIG

AQUAWAY® T 1585.2/90 P-LINE GB1

Toepassing:
Afvoeren van hemelwater, passende in de trottoirband.



Standaard:



Flex ring

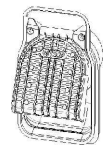

Scharnierende
Putklep

Bovenaanzicht

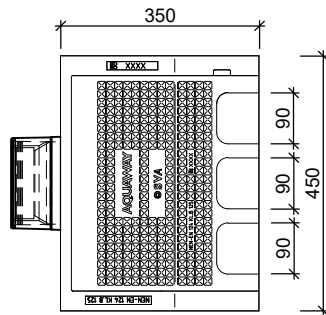

Zijaanzichten

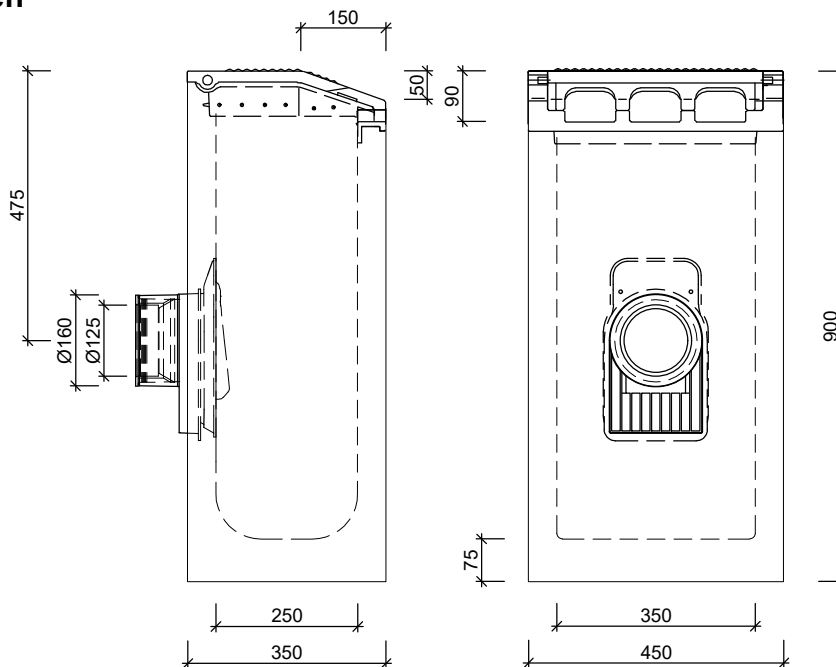

Toebehoren in optie:

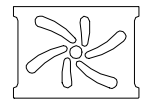

waaierdeksel B125

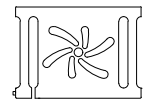

waaierdeksel B125
met vergrendeling

hoogte 700mm

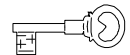

vergrendeling

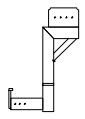

stelhelp kolken

Kenmerken	T 1585.2/90 P-LINE GB1	Principe			
afmetingen	450/350/900mm	aansluiting			
gewicht	184kg				
Ø aansluiting	FLEX DN125/DN160	voor 0	achter +	links +	rechts +
rooster inlaatopeningen	270cm ²	<p>Plaatsingsvoorschriften op aanvraag</p>			
stankslot	≥ 40mm				
zandvang	> 20dm ³				
gietijzer kwaliteit rand	GJL				
gietijzer kwaliteit rooster	GJS				
keur	KOMO				
verkeersbelastingsklasse	B125				
materiaal	beton / GY				
voor bandprofiel	5/20				

afmetingen in mm - wijzigingen voorbehouden

o product op verzoek (afname verplicht) / + standaard product / - niet leverbaar