

# TROTTOIRKOLKEN TWEEDELIG

## AQUAWAY® T 1350-1320 P-LINE GB2

Toepassing:  
Afvoeren van hemelwater, passende in de trottoirband.



### Bovenaanzicht

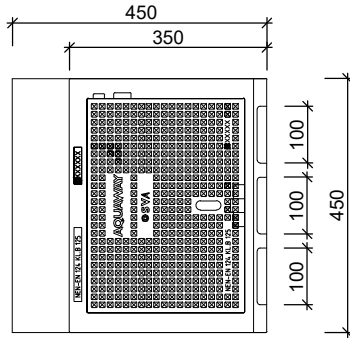

### Zijaanzichten

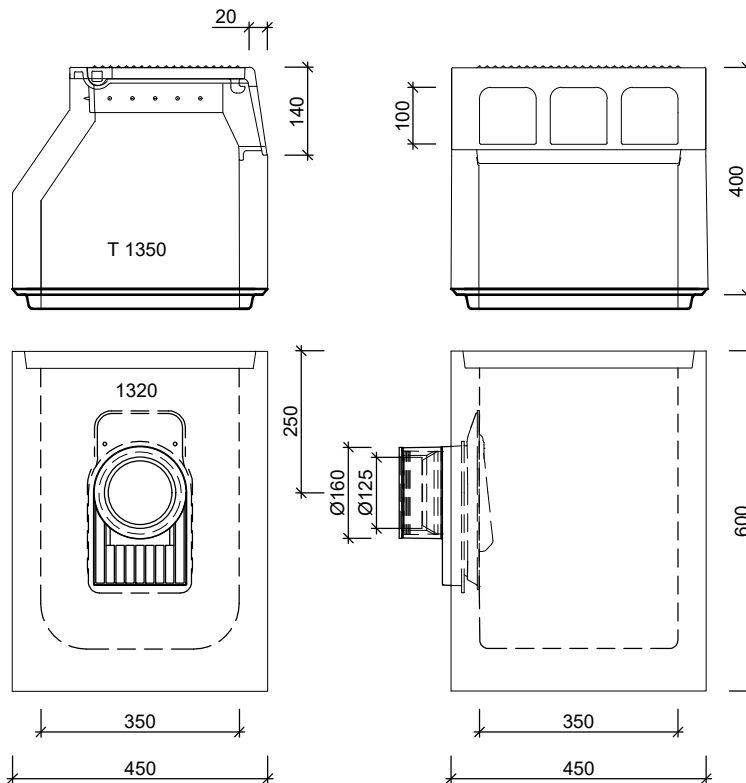

### Standaard:



Flex ring

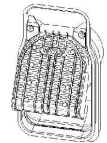

Scharnierende Putklep

### Toebehoren in optie:

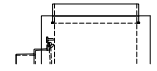

stalen geleiderand  
1355-1310

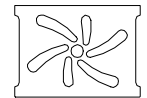

waaierdeksel  
B125

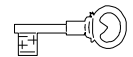

vergrendeling

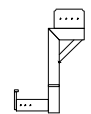

stelhulp kolken

Kenmerken		T 1350-1320 P-LINE GB2	Principe			
afmetingen		450x350/ 450x450/ 1000mm	aansluiting			
gewicht		BS 81kg / OB 146kg	voor	achter	links	rechts
Ø aansluiting		FLEX DN125/DN160	+	+	+	+
rooster inlaatopeningen		300cm <sup>2</sup>	<p>trotoir</p> <p>afvoer</p> <p>Plaatsingsvoorschriften op aanvraag</p>			
stankslot		≥ 40mm				
zandvang		> 20dm <sup>3</sup>				
gietijzer kwaliteit rand		GJL				
gietijzer kwaliteit rooster		GJS				
keur		KOMO				
verkeersbelastingsklasse		B125				
materiaal		beton / GY				
voor bandprofiel		13/15, 18/20, 28/30				

afmetingen in mm - wijzigingen voorbehouden

o product op verzoek (afname verplicht) / + standaard product / - niet leverbaar