

TROTTOIRKOLKEN TWEEDELIG

AQUAWAY® T 1370.3-1320 P-LINE GB2

Toepassing:
Afvoeren van hemelwater, passende in de trottoirband.



Bovenaanzicht

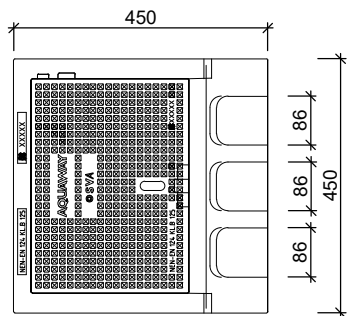

Standaard:



Flex ring

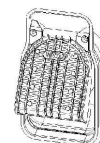

Scharnierende
Putklep

Zijaanzichten

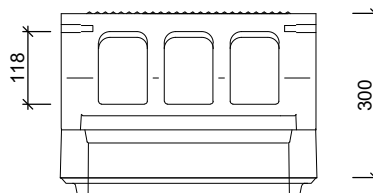
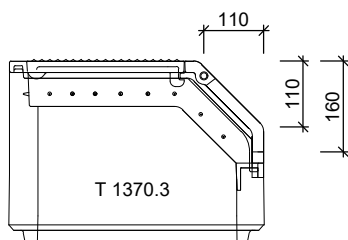

Toebehoren in optie:

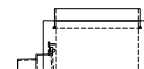

stalen geleiderand
1357-1310

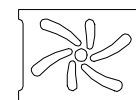
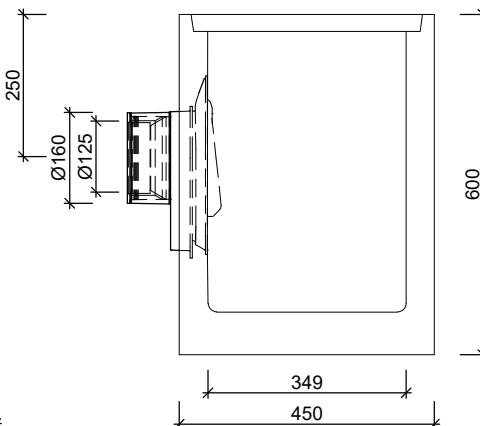
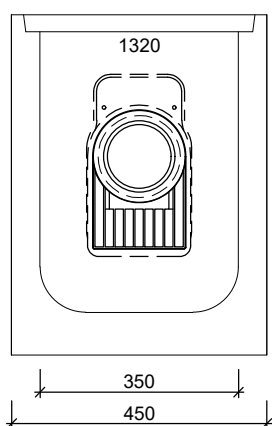

waaierdeksel
B125

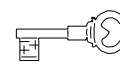

vergrendeling

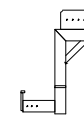

stelhulp kolken

Kenmerken		T 1370.3-1320 P-LINE GB2	Principe															
afmetingen		450/450/900mm	<table border="1"> <tr> <th colspan="4">aansluiting</th> </tr> <tr> <th>voor</th> <th>achter</th> <th>links</th> <th>rechts</th> </tr> <tr> <td>+</td> <td>+</td> <td>+</td> <td>+</td> </tr> </table>				aansluiting				voor	achter	links	rechts	+	+	+	+
aansluiting																		
voor	achter	links	rechts															
+	+	+	+															
gewicht		BS 74kg / OB 146kg	<p>Plaatingsvoorschriften op aanvraag</p>															
Ø aansluiting		FLEX DN125/DN160																
rooster inlaatopeningen		380cm ²																
stankslot		≥ 40mm																
zandvang		> 20dm ³																
gietijzer kwaliteit rand		GJL																
gietijzer kwaliteit rooster		GJS																
keur		KOMO																
verkeersbelastingsklasse		B125																
materiaal		beton / GY																
voor bandprofiel		RWS 11/22																

afmetingen in mm - wijzigingen voorbehouden

o product op verzoek (afname verplicht) / + standaard product / - niet leverbaar