

# TROTTOIRKOLK EENDELIG

## M-Line T1271/90 GB1

Toepassing:  
Afvoeren van hemelwater, passend in trottoirband

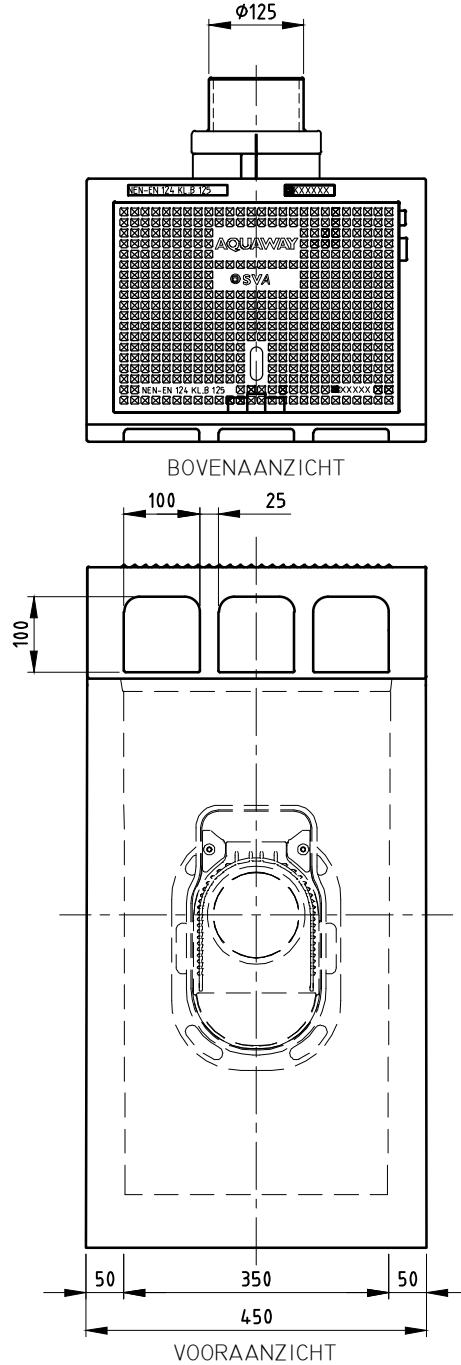
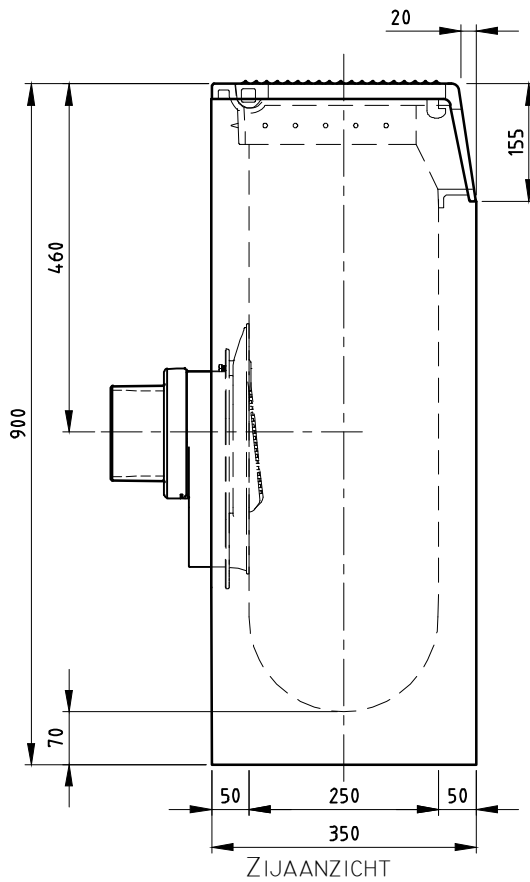

### TOEBEHOOR STANDAARD

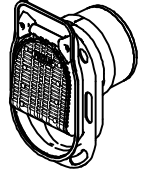

Scharnierende putklep

### TOEBEHOOR IN OPTIE



M-Line uitlaat Ø160

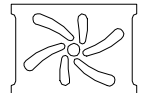

Waaierdeksel C250

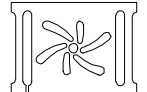

Waaierdeksel B125 met vergrendeling

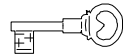

Vergrendeling

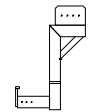

Stelhelp kolken

Kenmerken	M-Line T1271/90 GB1	Principe															
Afmetingen	450x350x900 mm	<table border="1"> <tr> <td colspan="4">aansluiting</td> </tr> <tr> <td>voor</td> <td>achter</td> <td>links</td> <td>rechts</td> </tr> <tr> <td>-</td> <td>+</td> <td>+</td> <td>+</td> </tr> </table>				aansluiting				voor	achter	links	rechts	-	+	+	+
aansluiting																	
voor	achter	links	rechts														
-	+	+	+														
Gewicht	135 kg																
Ø Aansluiting	DN125/DN160																
Rooster inlaatopeningen	300 cm <sup>2</sup>																
Stankslot	≥40 mm																
Zandvang	21 dm <sup>3</sup>																
Gietijzer kwaliteit rand	GJL																
Gietijzer kwaliteit rooster	GJS																
Keur	KOMO																
Verkeersbelastingsklasse	B125																
Materiaal	beton / GY																
Voor bandprofiel	13/15; 18/20, 28/30																

Plaatsingsvoorschriften op aanvraag

afmetingen in mm - wijzigingen voorbehouden

o product op verzoek (afname verplicht) / + standaard product / - niet leverbaar