

# TROTTOIRKOLK EENDELIG

## P-Line T1273.2/85 GR PET CAN GB1

Toepassing:  
Afvoeren van hemelwater, passend in de trottoirband

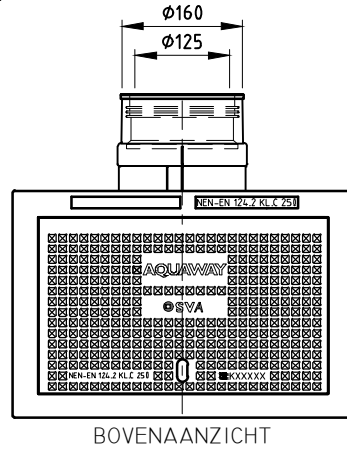

BOVENAANZICHT

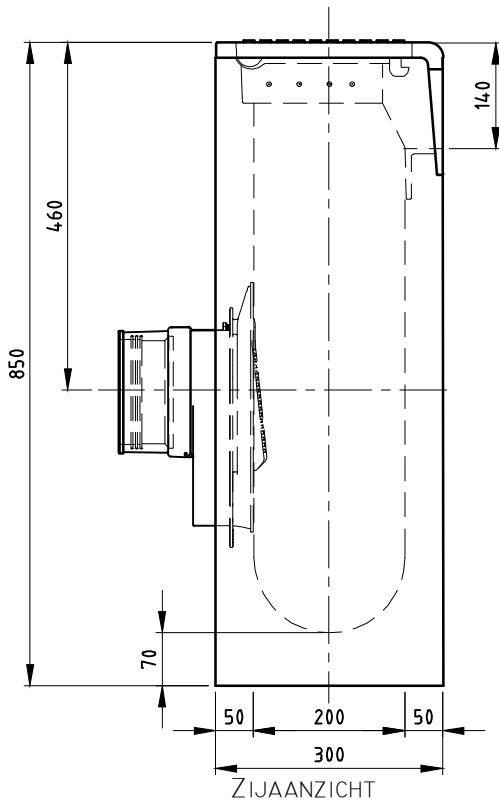

ZIJEAANZICHT

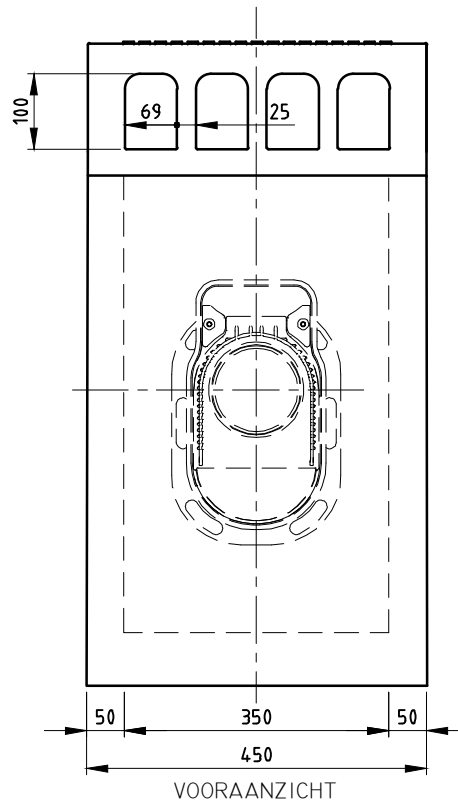

VOORAANZICHT

TOEBEHOOR STANDAARD

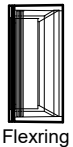

Flexring

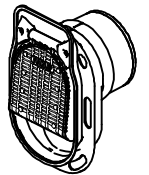

Scharnierende Putklep

TOEBEHOOR IN OPTIE

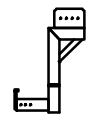

Stelhelp kolken

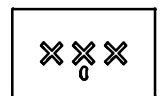

Logo Amsterdam

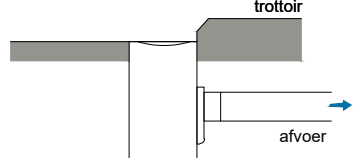
Kenmerken	P-Line T1273.2/85 GR PET CAN GB1	Principe			
Afmetingen	450x300x850 mm	aansluiting			
Gewicht	185 kg				
Ø Aansluiting	DN125 FLEX/DN160	voor -	achter +	links +	rechts +
Rooster inlaatopeningen	280 cm <sup>2</sup>				
Stankslot	≥40 mm				
Zandvang	8 dm <sup>3</sup>				
Gietijzer kwaliteit rand	GJL				
Gietijzer kwaliteit rooster	GJS				
Keur	KOMO				
Verkeersbelastingsklasse	C250				
Materiaal	beton / GY				
Voor bandprofiel	10/20; 15/25; 30/20				

afmetingen in mm - wijzigingen voorbehouden

o product op verzoek (afname verplicht) / + standaard product / - niet leverbaar