

TROTTOIRKOLK EENDELIG

P-Line T1585.2/60 GB1

Toepassing:

Afvoeren hemelwater, passend in de trottoirband

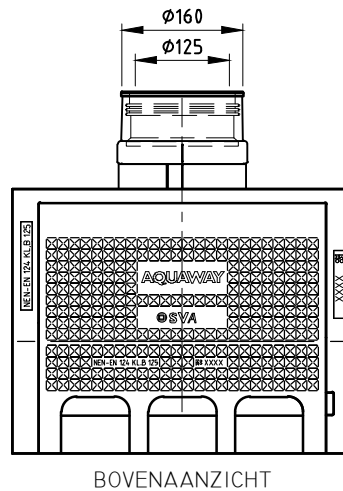

BOVENAANZICHT

TOEBEHOOR STANDAARD



Flexring

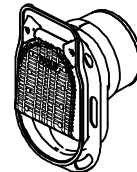

Scharnierende putklep

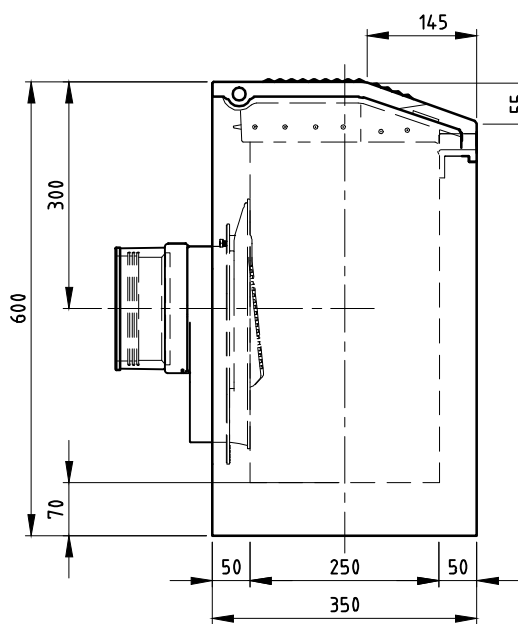

ZIJAAANZICHT

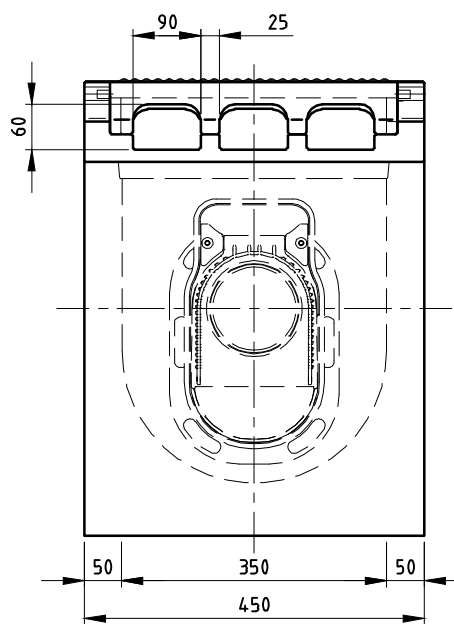

VOORAANZICHT

TOEBEHOOR IN OPTIE

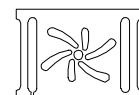

Waaierdeksel B125 met vergrendeling

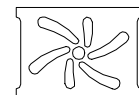

Waaierdeksel C250

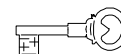

Vergrendeling

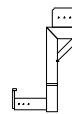

Stelhulp kolken

Kenmerken	P-Line T1585.2/60 GB1	Principe			
Afmetingen	450x350x600 mm	aansluiting			
Gewicht	130 kg				
Ø Aansluiting	DN125 FLEX/DN160	voor -	achter +	links +	rechts +
Rooster inlaatopeningen	270 cm ²				
Stankslot	≥40 mm				
Zandvang	14.8 dm ³				
Gietijzer kwaliteit rand	GJL				
Gietijzer kwaliteit rooster	GJS				
Keur	KOMO				
Verkeersbelastingsklasse	B125				
Materiaal	beton / GY				
Voor bandprofiel	5/20				

afmetingen in mm - wijzigingen voorbehouden

o product op verzoek (afname verplicht) / + standaard product / - niet leverbaar