

# TROTTOIRKOLK EENDELIG

## P-Line T1587.3/90 GB1

Toepassing:  
Afvoeren van hemelwater passend in de trottoirband

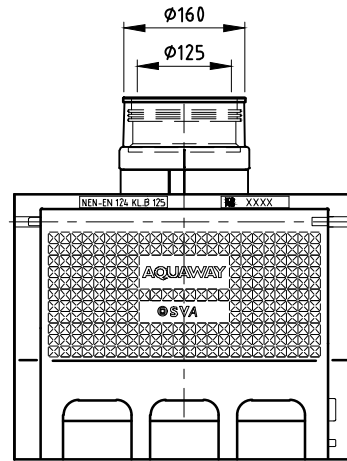

BOVENAANZICHT

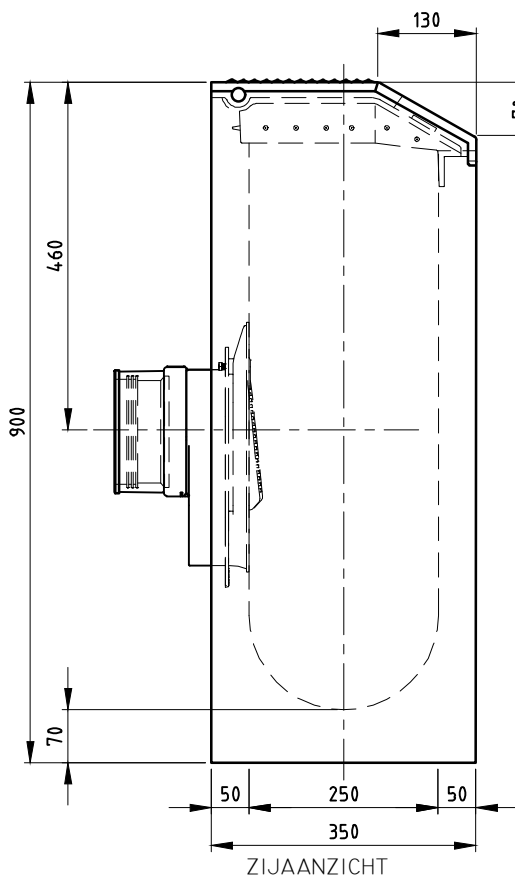

ZIJAANZICHT

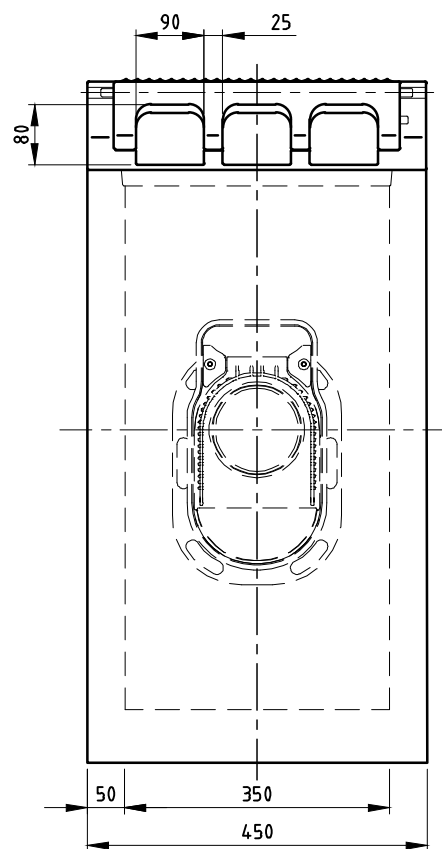

VOORAANZICHT

### TOEBEHOOR STANDAARD



Flexring

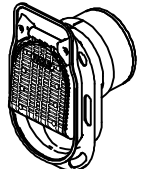

Scharnierende putklep

### TOEBEHOOR IN OPTIE

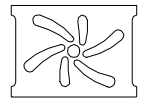

Waaierdeksel C250

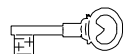

Vergrendeling

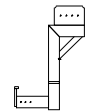

Stelhelp kolken

Kenmerken		P-Line T1587.3/90 GB1	Principe			
Afmetingen		450x350x900 mm	aansluiting			
Gewicht		184 kg	voor	achter	links	rechts
Ø Aansluiting		DN125 FLEX/DN160	-	+	+	+
Rooster inlaatopeningen		215 cm <sup>2</sup>				
Stankslot		≥40 mm				
Zandvang		21 dm <sup>3</sup>				
Gietijzer kwaliteit rand		GJL				
Gietijzer kwaliteit rooster		GJS				
Keur		KOMO				
Verkeersbelastingsklasse		C250				
Materiaal		beton / GY				
Voor bandprofiel		7/20				

afmetingen in mm - wijzigingen voorbehouden

o product op verzoek (afname verplicht) / + standaard product / - niet leverbaar